

Article number: 204801V10100ALOS

Description: E+G Retaining tube without scales - GN 480.1-V10-100-AL-OS

Measures

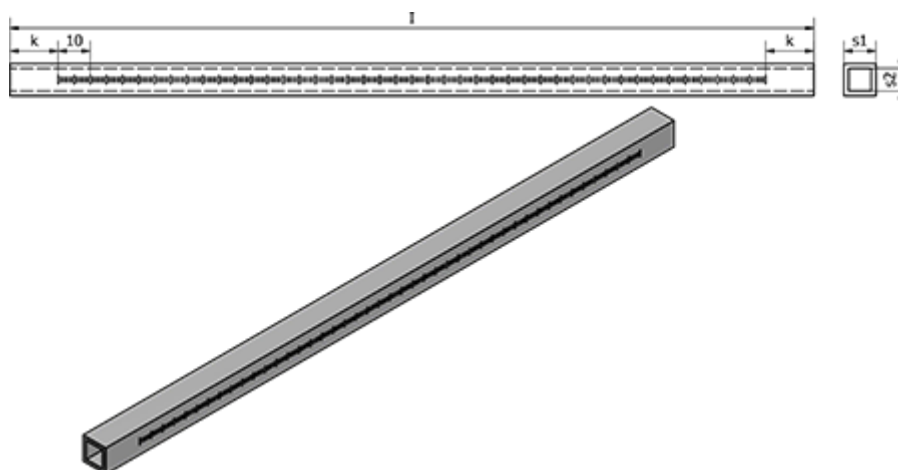

l	=	100
k	=	15
s1	=	V10
s2	=	7
Weight (g)	=	11